

TRIPLE-R 28 ELITE

The iconic Triple-R range is upgraded for 2020/21. The Triple-R 28 has been given Elite level performance through the adoption of a combination of the latest high efficiency LED technologies and modified optics, used to deliver more distance illumination and more left/right spread of light, now delivering an incredible 28,560 lumens. Borne out of extensive testing at the highest levels of professional track and rally motorsport, the Triple-R Elite represents the pinnacle of LED driving light technology. Subtle styling updates have resulted in a clean contemporary design, with a more aggressive edge, to match the aesthetic design prevalent on modern vehicles.

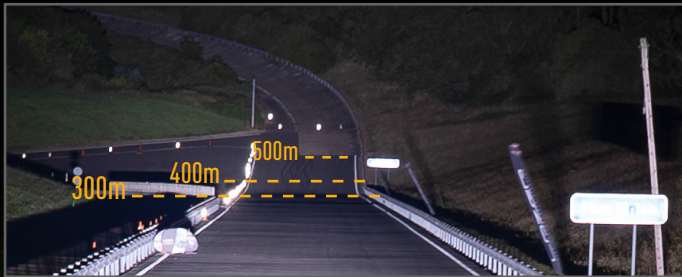

100m
200m

SEE MORE. **GO FASTER.** GO SAFER.

TRIPLE-R 28 ELITE

- Ultra long-range optics optimised for road and race applications
- High intensity LED's deliver exceptional luminosity and left/right spread
- Component technology shared with WRC lighting solutions
- CAE optimised heatsink
- Electronic thermal management
- 'Unbreakable' polycarbonate lens with hardcoat

MOUNTING OPTIONS

CENTRE MOUNT



SIDE MOUNT

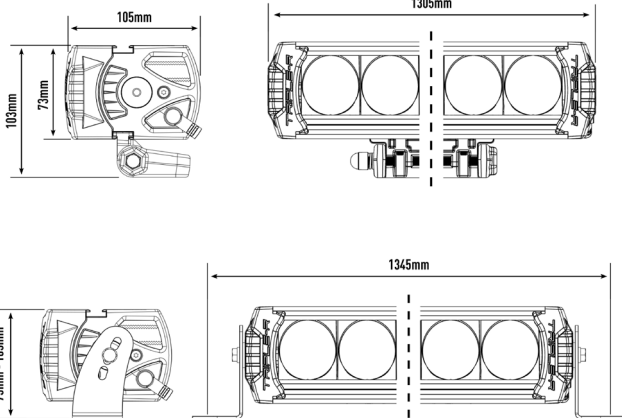

E-MARK REF	N/A
VOLTAGE RANGE	10V - 32V
RAW LUMENS	28,560
BEAM PATTERN	Spot
BEAM DISTANCE (0.25LX)	2506m
# HIGH POWER LEDS	28
POWER CONSUMPTION	326 Watts
CURRENT DRAW†	22.6 Amps
LED LIFE	50,000 Hrs*
WEIGHT	5100g

IP67
WATERPROOF

5 YEAR
WARRANTY

* LED Manufacturers Specifications †At 14.4 Volts

Horizontal: 30° / Vertical: 15° (2% of peak)

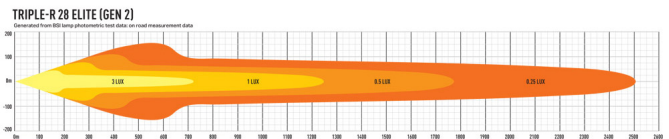
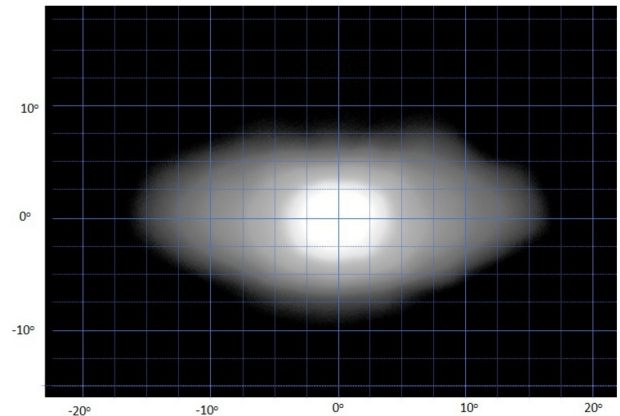

LAZER LAMPS LTD, Units 1+2, Harlow Mill Business Centre, Riverway, Harlow, Essex. CM20 2FD. UK
Tel: +44(0)1992 677374 | Email: sales@lazerlamps.com | Web: www.lazerlamps.com

