

TRIPLE-R 850

INCLUDES POSITION LIGHT

The iconic Triple-R range is upgraded for 2020/21. Boasting the very latest high efficiency LED technology, the Triple-R 850 is a high-performance driving light that delivers an impressive 6,930 lumens in the form of a spot beam pattern which is well suited to both road and off-road applications. The Triple-R 850 comes with the option to connect an amber or white integrated position/side light function, for when the requirement is for a light installation that gets noticed as much during the day as at night.



100m 200m

LAZER
HIGH PERFORMANCE LIGHTING

SEE MORE. **GO FASTER.** GO SAFER.

TRIPLE-R 850

INCLUDES POSITION LIGHT

- Ultra long-range optics optimised for road and race applications
- High intensity LED's deliver exceptional luminosity and left/right spread
- Component technology shared with WRC lighting solutions
- CAE optimised heatsink
- Electronic thermal management
- 'Unbreakable' polycarbonate lens with hardcoat
- Integrated white or amber position lights

MOUNTING OPTIONS

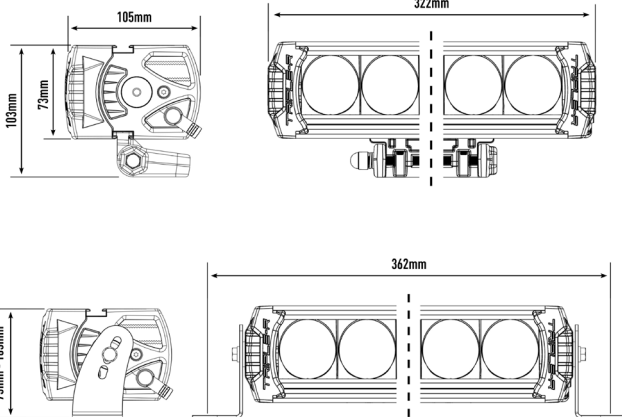
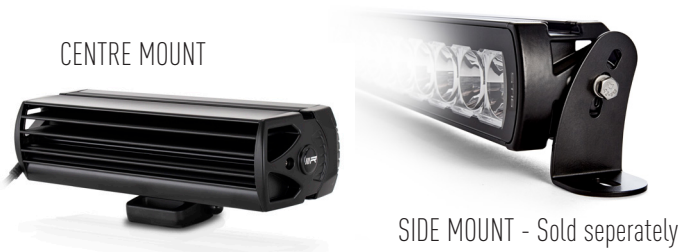

E-MARK REF	45
VOLTAGE RANGE	10V - 32V
RAW LUMENS	6,930
BEAM PATTERN	Spot
BEAM DISTANCE (0.25LX)	1061m
# HIGH POWER LEDS	8
POWER CONSUMPTION	66 Watts
CURRENT DRAW†	4.6 Amps
LED LIFE	50,000 Hrs*
WEIGHT	1340g



* LED Manufacturers Specifications †At 14.4 Volts

Horizontal: 19.2° / Vertical: 18° (2% of peak)

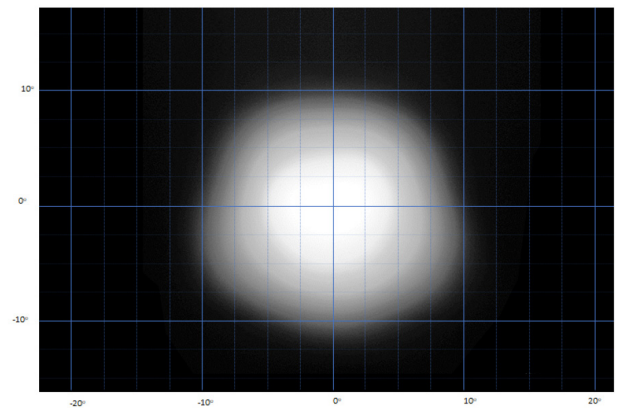

TRIPLE-R 850 (GEN 2)

GENERATED FROM BSI LAMP PHOTOMETRIC TEST DATA: ON ROAD MEASUREMENT DATA

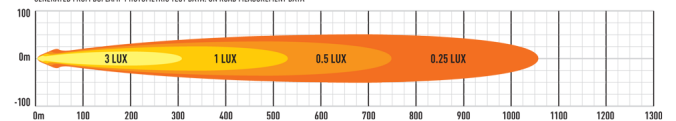

LAZER LAMPS LTD, Units 1+2, Harlow Mill Business Centre, Riverway, Harlow, Essex. CM20 2FD. UK
Tel: +44(0)1992 677374 | Email: sales@lazerlamps.com | Web: www.lazerlamps.com

