

ALSO AVAILABLE



FORD RANGER 2016+
GRILLE INTEGRATION KIT



FORD TRANSIT CUSTOM 2018+
GRILLE INTEGRATION KIT



FORD TRANSIT 2019+
GRILLE INTEGRATION KIT



FORD TRANSIT CONNECT 2018+
GRILLE INTEGRATION KIT



FORD TRANSIT COURIER 2014+
GRILLE INTEGRATION KIT



FORD RANGER / RAPTOR
ROOF MOUNTING KITS



FORD RAPTOR 2019+
LOWER GRILLE MOUNTING KIT



FORD RANGER 2016+
LOWER GRILLE MOUNTING KIT

FITTING INFORMATION

SIDE MOUNTING INFORMATION

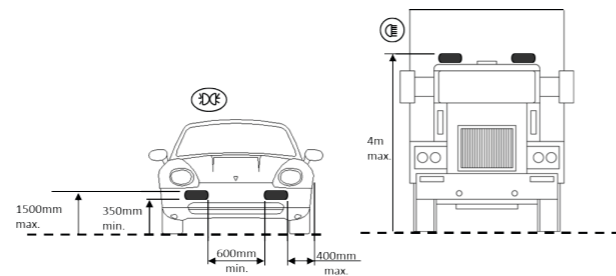
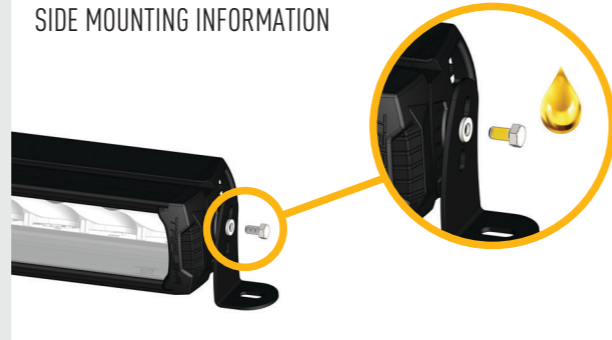

EN Lamps with integrated Position light may need to be positioned according to the above sketch. If an additional pair of position lights is not permitted (e.g. in Switzerland, Austria), the position light should be disconnected. The legal regulations in individual countries must be observed.

FR Lors du montage d'un phare de complément avec feu de position intégré, toutes les cotes de montage supplémentaires indiquées dans le croquis ci-dessus doivent être respectées. Si ces spécifications de montage légales ne sont pas respectées, ou si l'utilisation d'une paire supplémentaire de feux de position n'est pas autorisée (Suisse, Autriche), le feu de position ne doit pas être utilisé. Dans ce cas, les câbles du feu de position doivent être débranchés. La législation spécifique à chaque pays doit être observée.

DE Bei Anbau eines Zusatzscheinwerfers mit integriertem Positionslicht sind in Deutschland alle in nebenstehender Skizze aufgeführten zusätzlichen Anbaumaße einzuhalten. Sollten diese gesetzlichen Anbauvorschriften nicht eingehalten werden, bzw. die Benutzung eines zusätzlichen Paares Positionsleuchten nicht zulässig sein (CH, A) darf das Positionslicht nicht betrieben werden. Landesspezifische Gesetzeslage ist zu beachten.

NO Lamper med posisjonslys / parklys må muligens plasseres ifølge tegningen over. NB: i Norge er det kun lov med to parklys totalt.

SE Lampor med integrerat positionsljus rekommenderas att placeras enligt ovanstående skiss. Om det inte är tillåtet med ytterligare ett par positionsljus på fordonet (t.ex. i Schweiz, Österrike), bör positionsljuset kopplas bort. Lagstiftningen ska följas enligt varje enskilt land.

FI Parkkivaloilla varustetut mallit tulee asemoida yllä olevan piirroksen mukaisesti. Mikäli parkkivalot eivät ole maakohtaisesti (mm. Sveitsi, Itävalta) laillisia tieliikenteeseen, ei niitä tule kytkeä käyttöön. Maakohtaisia liikennelain asetuksia tulee aina noudattaa.

WHAT'S INCLUDED

- 4x Grille Mounting Brackets
- 4x Cutter Guides
- Fitting Instructions

Additionally - Kit Includes:

- 2x High Performance LED Spotlights (Triple-R 750)
- 1x Two-Lamp Wiring Kit

TOOLS REQUIRED

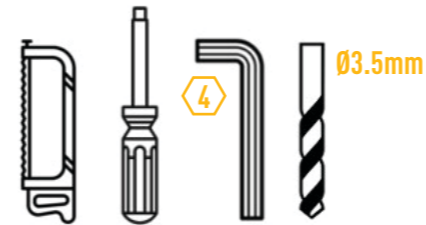

LAZER
HIGH PERFORMANCE LIGHTING

WWW.LAZERLAMPS.COM

+44 (0)1992 677374
sales@lazerlamps.com

Lazer Lamps Ltd, Units 1&2 Harlow Mill Business Centre,
Riverway, Harlow, Essex. CM20 2FD. United Kingdom

MADE IN THE UK /LAZERLAMPS /LAZERLAMPS

LAZER
HIGH PERFORMANCE LIGHTING



FORD RANGER 2019+
GRILLE INTEGRATION KIT

FITTING INSTRUCTIONS

INSTALLATION PROCESS

Install should be completed with the grille left on the vehicle.

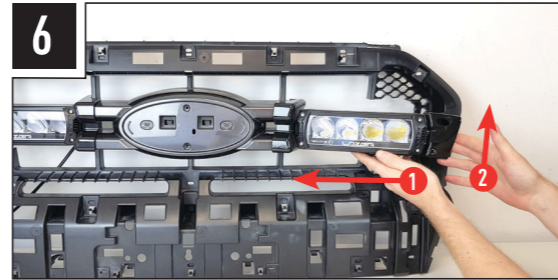
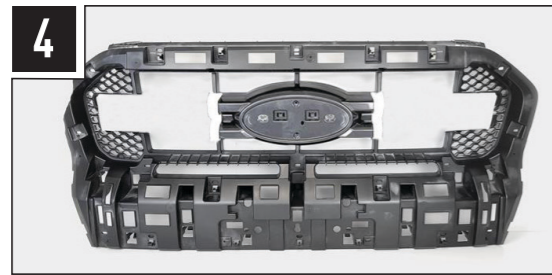
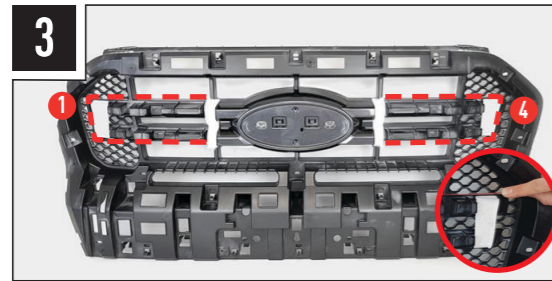
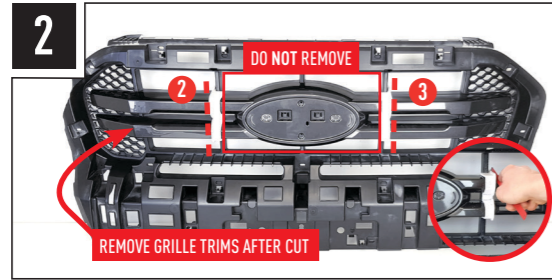
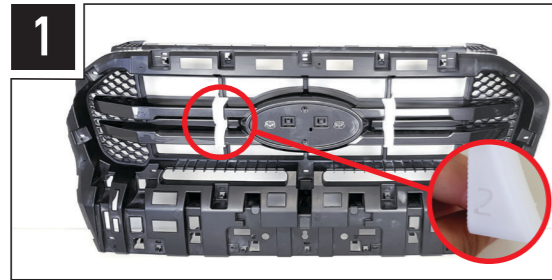

TORQUE VALUES

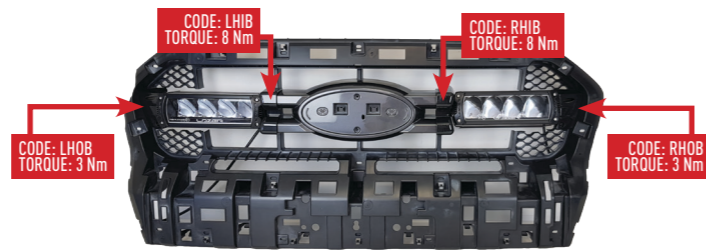

ELECTRICAL CONNECTION

TRIPLE-R 750 STANDARD

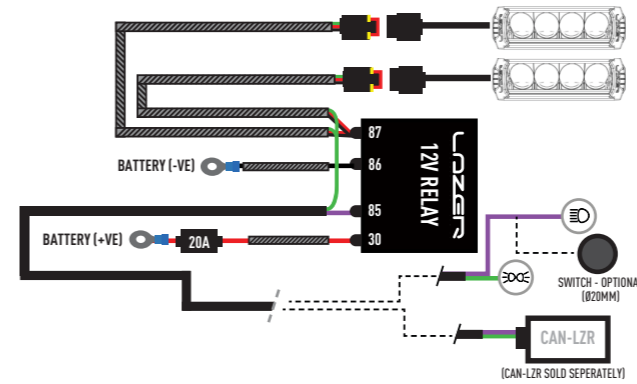

TRIPLE-R 750 ELITE

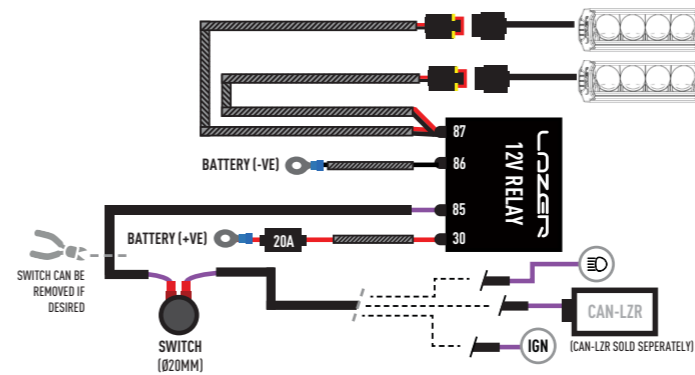

TRIPLE-R - POSITION LIGHT FUNCTION (OPTIONAL)

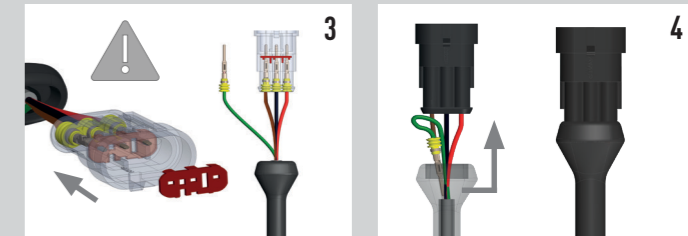
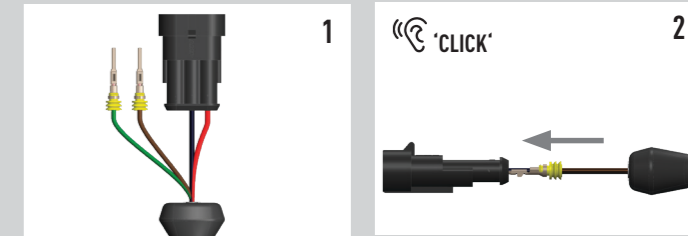

CANBUS INTEGRATION

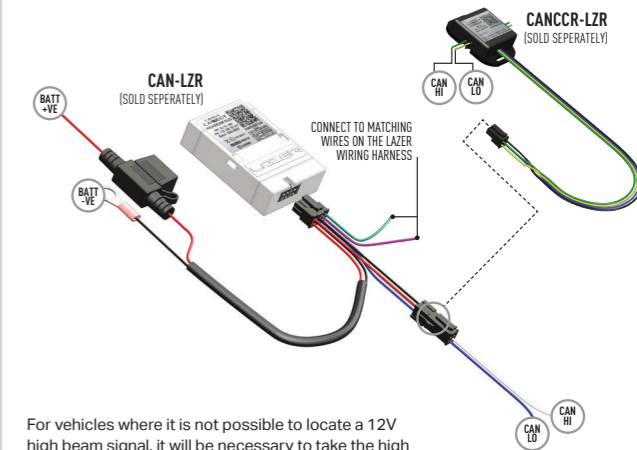

For vehicles where it is not possible to locate a 12V high beam signal, it will be necessary to take the high beam signal from the vehicle's CAN system. For vehicle specific CAN instructions, please download the "CANM8 Connect" App.