

# TRIPLE-R 1250

## SMARTVIEW



### TRIPLE-R SMARTVIEW | FUNCTIONALITY



#### **E9** E-MARK COMPLIANT MODE

Enables the customer to operate the lamp in compliance with EU road-legal requirements.



#### **▼** E-BOOST MODE

Increases the intensity of light for maximum visibility. Off-Road use only.

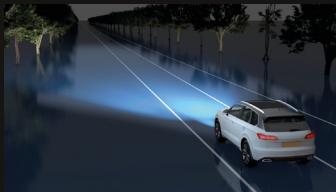

#### **▼** NEAR-VIEW MODE

Provides superior levels of short-range illumination, ideal in more extreme weather conditions such as fog and snow.

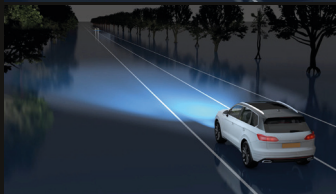

#### **↔** DYNAMIC DIP

Delivers a smoother transition between high and low beam allowing time for the driver's eyes to adjust to lower light levels.



#### **30mph** SPEED ADAPT MODE

Beam pattern adjusts depending on the speed of the vehicle between 30mph/50kph - 50mph/80kph. Requires CanM8 Duo Interface.

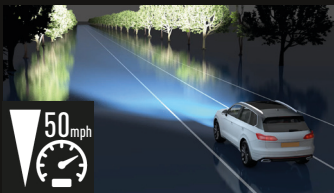

**BOASTING INNOVATIVE FUNCTIONALITY THAT PROVIDES FOR ENHANCED SAFETY, COUPLED WITH LIGHTING PERFORMANCE AT THE PEAK OF LED TECHNOLOGY, THE TRIPLE-R SMARTVIEW IS THE PINNACLE OF AUTOMOTIVE LIGHTING TECHNOLOGY.**

Integrated into your vehicle's electrical system via an Anti-Theft Module boasting 'Plug & Play' connectivity, the Smartview allows operation of 5 different lighting modes. Operated by a touchscreen 'Dashboard Controller', each mode delivers real-world benefits suited to different road and off-road applications and conditions, and each benefitting from the latest and most efficient LED technology to deliver unrivalled lighting performance like no other.

# TRIPLE-R 1250 SMARTVIEW

- Low Beam assist technology
- Ultra long-range optics optimised for road and rural driving
- High intensity LED's deliver exceptional luminosity and left/right spread
- Component technology shared with WRC lighting solutions
- CAE optimised heatsink
- Electronic thermal management
- 'Unbreakable' polycarbonate lens with hardcoat
- E-Boost technology

## MOUNTING OPTIONS

CENTRE MOUNT



SIDE MOUNT - Sold seperately

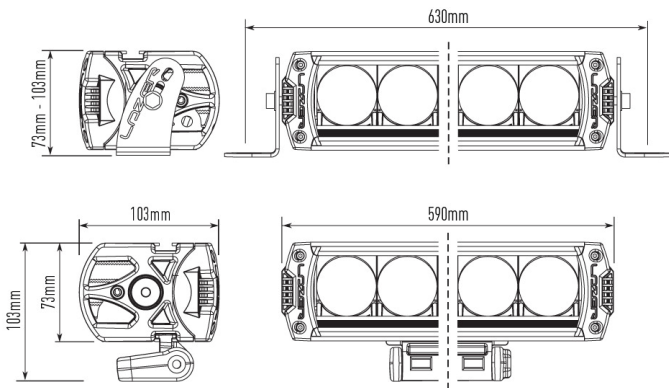

\* LED Manufacturers Specifications †At 14.4 Volts

E-MARK REF	45
VOLTAGE RANGE	10V - 32V
RAW LUMENS	12,170
BEAM PATTERN	VARIOUS
BEAM DISTANCE (0.25LX)	1463m
# HIGH POWER LEDS	12
POWER CONSUMPTION	105 Watts
CURRENT DRAW†	7.3 Amps
LED LIFE	50,000 Hrs*
WEIGHT	1940g



Horizontal: 21° / Vertical: 9° (2% of peak)

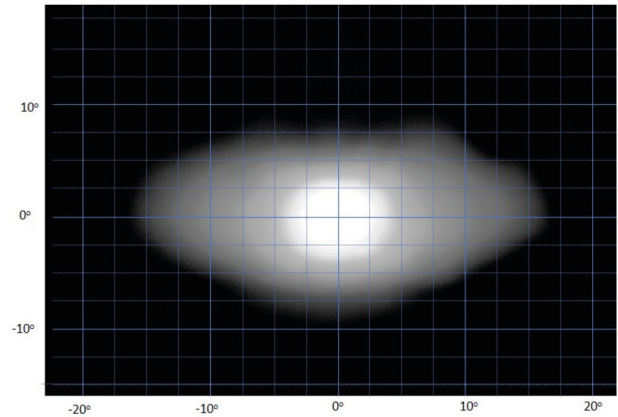

TRIPLE-R 1250 SMARTVIEW – BOOST FUNCTION ENGAGED\*

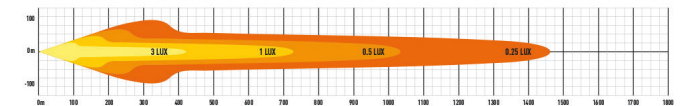

\*BOOST FUNCTION IS ENGAGED WHEN SELECTED VIA THE DASHBOARD CONTROLLER.

TRIPLE-R 1250 SMARTVIEW – E-MARK COMPLIANT MODE

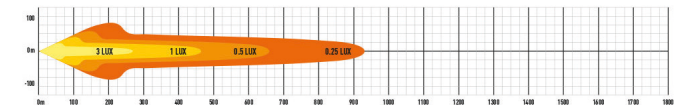

LAZER LAMPS LTD, Units 1+2, Harlow Mill Business Centre, Riverway, Harlow, Essex. CM20 2FD. UK  
Tel: +44(0)1992 677374 | Email: sales@lazerlamps.com | Web: www.lazerlamps.com

